

INTERNATIONAL AEROBATIC CLUB SCORESHEET

A

Contest:

Date:

2023



Category:

 Power
Unlimited

Programme:

Known

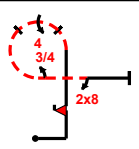
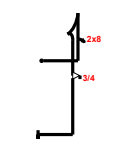
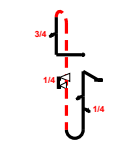
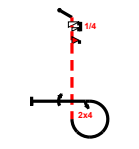
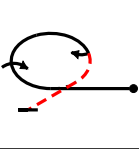
 pilot's
number

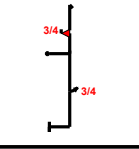
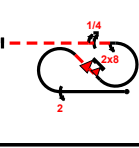
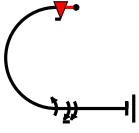
No	Symbol	Cat. No.	K	Total K	Grade	Remarks	Item	K	Score	
1		8.6.4.1 9.10.6.2 9.4.3.4 9.1.3.3 9.8.3.1	14 19 11 6 3	53			Presentation	40		
			SF 7							
2		6.2.1.1 9.8.1.1 9.9.5.3	15 7 11	33					FIGURE TOTAL K =	382
			SF 6							INC. PRESENTATION =
Aircraft type:										
3		8.8.6.1 9.1.1.3 9.9.10.5 9.1.1.1 9.1.1.2	21 10 15 6 8	60						
			SF 7							
4		8.6.4.3 9.11.1.5 9.10.5.2 9.4.3.2 9.1.3.4	13 4 13 5 8	43						
			SF 7							
5		2.3.2.1	34	34						
			SF 2							
6		8.4.2.2 9.1.5.5	17 9	26						
			SF 7							
7		5.2.1.1 9.10.6.3 9.1.5.3	17 19 6	42						
			SF 5							
8		7.5.2.1 9.2.3.4 9.10.4.6 9.8.3.1 9.1.3.5	15 9 16 3 9	52						
			SF 7							
9		7.2.1.4 9.10.3.4 9.1.3.4 9.1.3.8	6 13 8 12	39						
			SF 7							

FREE PROGRAM CHECKED BY:

Signature:

Printed Name:

IAC No:

Date:

 Judge
Name:

IAC #

 Assistant
Name:

IAC #



Pilot

A/C



B	Contest:	Category:
	Date: 2023	Program: Known
Pilot's No. <input type="text"/>		

Pilot:

wind direction

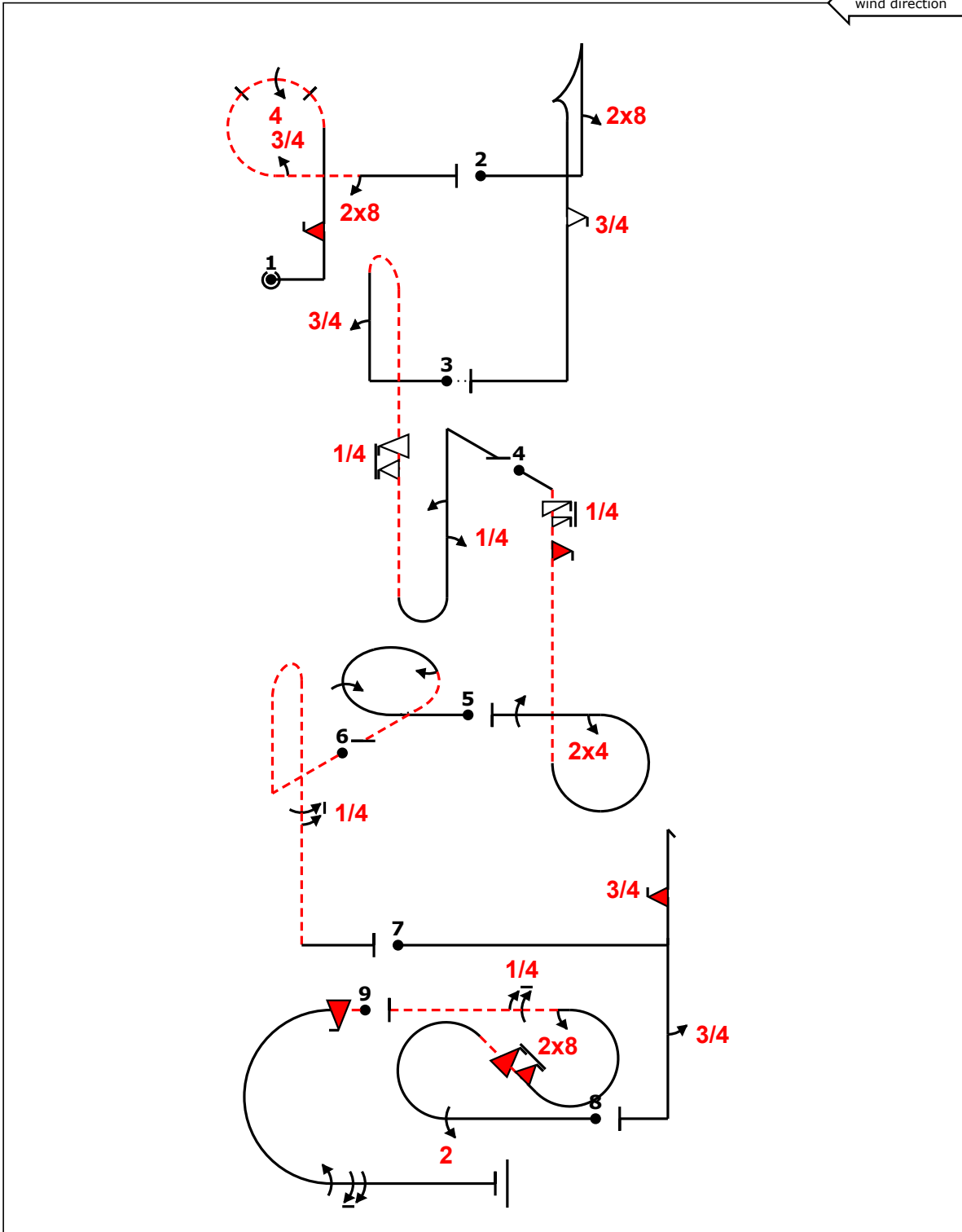

A/C:

(signature/date)

FREE PROGRAM CHECK BY:



C	Contest:	Category:
	Date: 2023	Program: Known
Pilot's No. <input type="text"/>		

Pilot:

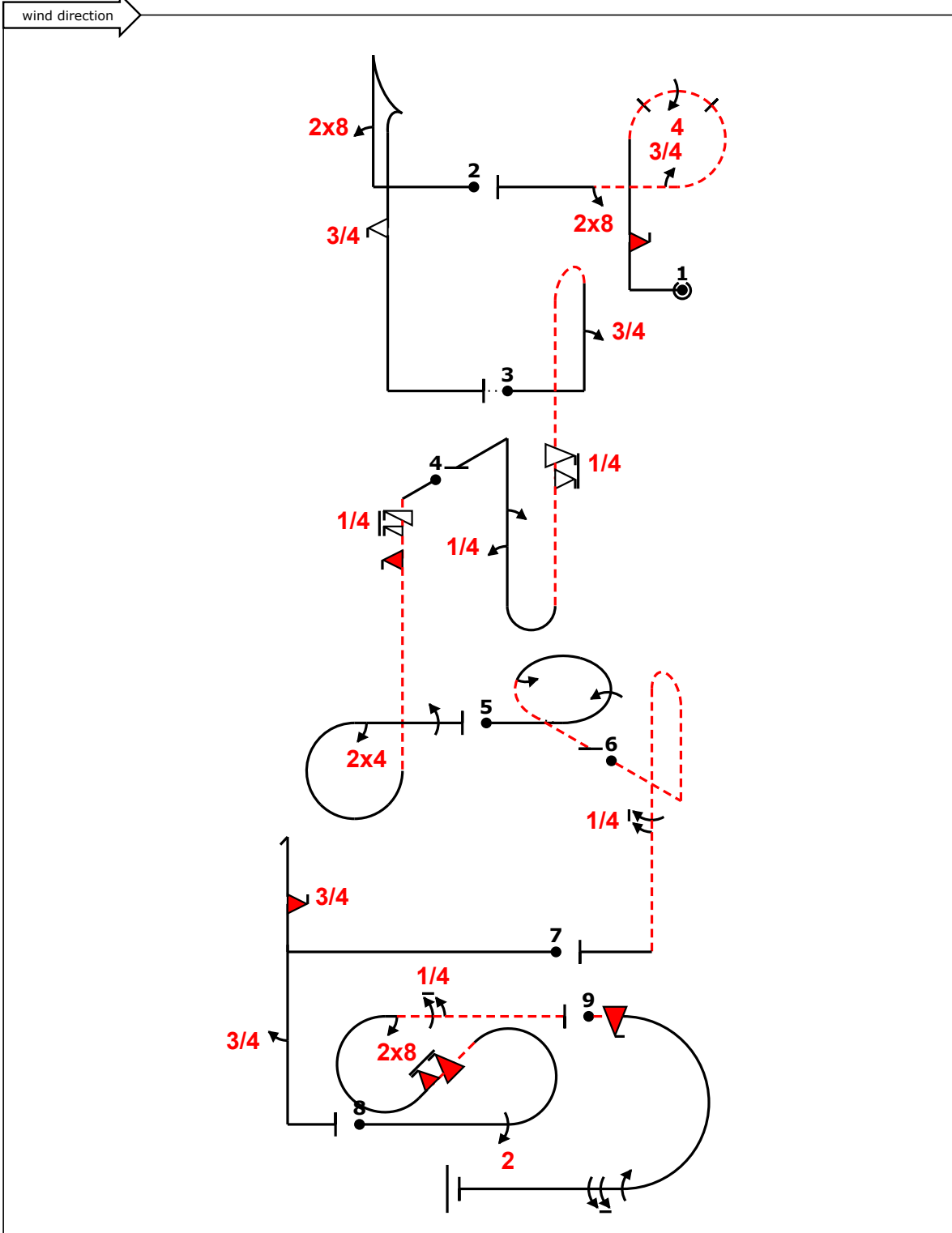

A/C:

(signature/date)

FREE PROGRAM CHECK BY: