

INTERNATIONAL AEROBATIC CLUB SCORESHEET

A

Contest:

Date:















Category:

Unlimited

Programme:

Unknown1

pilot's number

No	Symbol	Cat. No.	K	Total K	Grade	Remarks	Item	K	Score		
1		8.6.2.1 9.8.1.1 9.1.1.3 9.10.8.4 9.1.3.7 9.1.3.5	12 7 10 15 11 9	Fig B 64			Presentation 20 				
2		1.1.7.2	12	connect 6				FIGURE TOTAL K =		460	
3		7.4.1.3 9.4.3.4	14 11	Fig J 25				INC. PRESENTATION =		480	
4		8.4.4.3 9.11.1.6 9.4.5.3 9.1.1.5	14 3 8 14	Fig H 39				Aircraft type:			
5		1.1.6.4 9.1.5.2	10 4	connect 6				FREE PROGRAM CHECKED BY: Signature: Printed Name: IAC No: Date: 			
6		7.2.3.2 9.2.3.6 9.1.3.3 9.4.3.3	7 12 6 8	Fig G 33					Judge Name:		
7		5.2.1.2	23	connect 6					IAC #		
8		5.3.1.4 9.1.2.5 9.8.2.1 9.10.5.3	23 11 5 13	Fig A 52					Assistant Name:		
9		8.6.3.1 9.9.1.3 9.2.3.8 9.1.3.8 9.1.3.4	15 15 15 12 8	Fig F 65					IAC #		
10		5.2.1.4 9.1.5.2	22 4	connect 6							
11		7.4.5.1 9.4.2.3 9.1.2.3 9.9.9.4	15 10 8 13	Fig D 46							
12		1.2.4.1 9.1.2.2 9.10.2.4 9.1.5.3	13 6 15 6	Fig C 40							
13		6.2.2.4 9.1.1.2 9.4.1.3 9.1.5.2	17 8 12 4	Fig I 41							
14		7.4.3.1 9.10.3.2 9.1.3.2	14 13 4	Fig E 31							



_____ Pilot
 _____ AVC



B	Contest:	Category:
	Date:	Program: Unknown1

Pilot:

wind direction

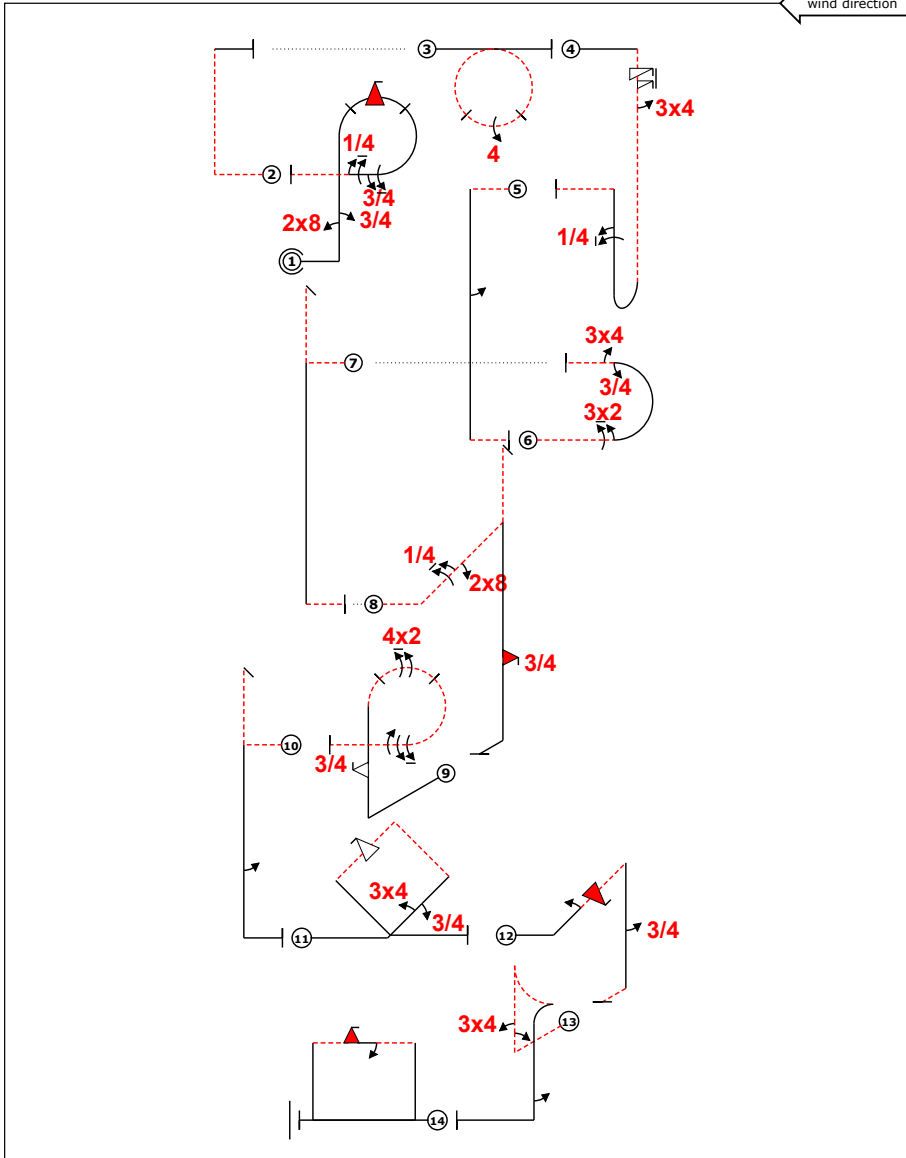

A/C:
FREE PROGRAM CHECK BY: (signature/date)



C	Contest:	Category:
	Date:	Program: Unknown1

Pilot:

wind direction

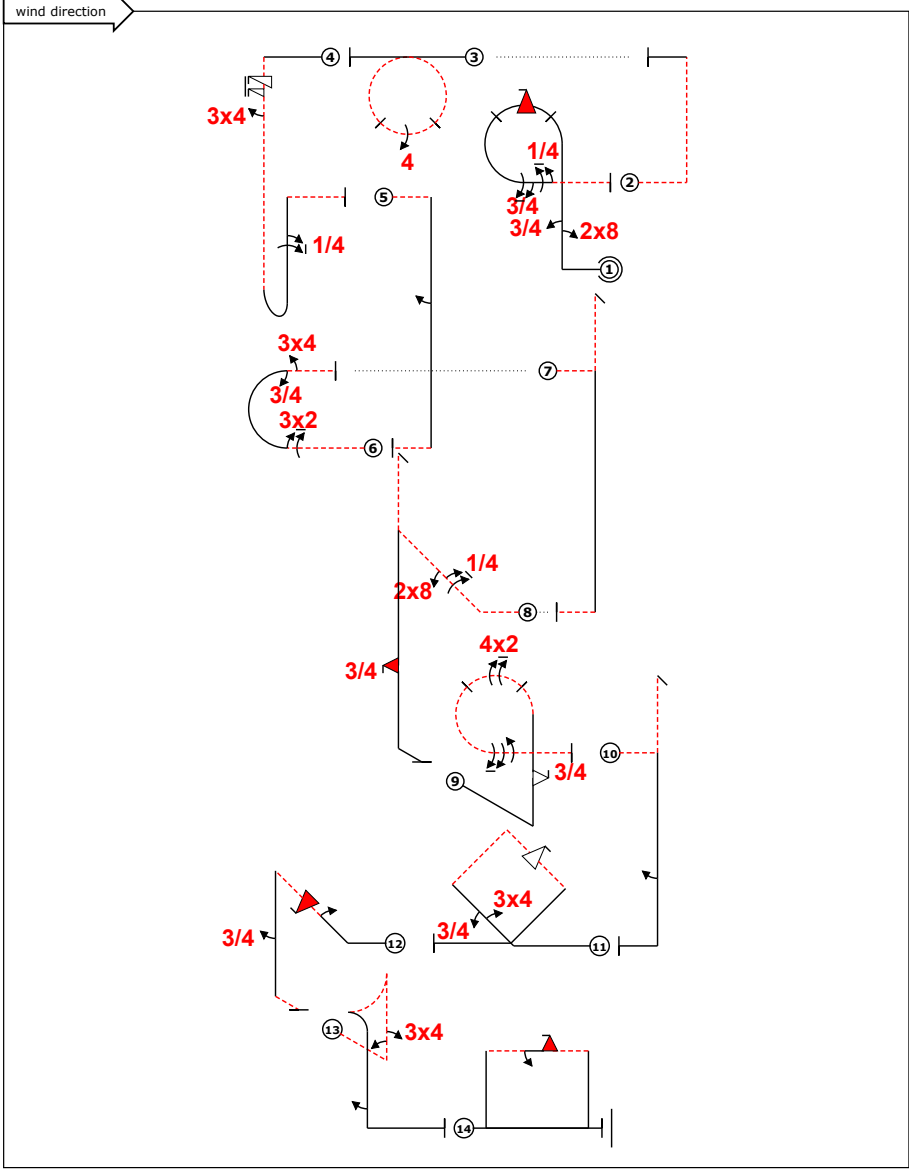

A/C:

(signature/date)

FREE PROGRAM CHECK BY: