

# INTERNATIONAL AEROBATIC CLUB SCORESHEET

# A

Contest:

Date:















Category:

Unlimited

Programme:

Unknown1

pilot's number

No	Symbol	Cat. No.	K	Total K	Grade	Remarks	Item	K	Score	
1		8.6.2.1 9.8.1.1 9.1.1.3 9.10.8.4 9.1.3.7 9.1.3.5	12 7 10 15 11 9	64			<b>Presentation</b> 20 <span style="border: 1px solid black; padding: 2px 10px;"> </span>			
2		1.1.10.2	11	connect 6		FIGURE TOTAL K = <span style="border: 1px solid black; padding: 2px 10px;">460</span>				
3		7.4.1.3 9.4.3.4	14 11	25		INC. PRESENTATION = <span style="border: 1px solid black; padding: 2px 10px;">480</span>				
4		8.4.4.3 9.11.1.6 9.4.5.3 9.1.1.5	14 3 8 14	39		Aircraft type: <div style="border: 1px solid black; height: 20px; width: 100%;"></div>				
5		1.1.7.4	9	connect 6		FREE PROGRAM CHECKED BY: Signature: <div style="border: 1px solid black; width: 100%; height: 40px; display: flex; align-items: center; justify-content: center;"> <span style="writing-mode: vertical-rl; transform: rotate(180deg); font-size: 0.8em;">Printed Name:</span> <span style="writing-mode: vertical-rl; transform: rotate(180deg); font-size: 0.8em;">Date:</span> </div> IAC No: <div style="border: 1px solid black; width: 100%; height: 40px; display: flex; align-items: center; justify-content: center;"> <span style="writing-mode: vertical-rl; transform: rotate(180deg); font-size: 0.8em;">IAC No:</span> </div>				
6		1.2.4.1 9.1.2.2 9.10.2.4 9.1.5.3	13 6 15 6	40				Judge Name: <div style="border: 1px solid black; width: 100%; height: 20px;"></div>		
7		6.2.2.4 9.1.1.2 9.4.1.3 9.1.5.2	17 8 12 4	41				IAC # <div style="border: 1px solid black; width: 100%; height: 20px;"></div>		
8		8.4.2.1	14	connect 6				Assistant Name: <div style="border: 1px solid black; width: 100%; height: 20px;"></div>		
9		5.3.1.4 9.1.2.5 9.8.2.1 9.10.5.3	23 11 5 13	52				IAC # <div style="border: 1px solid black; width: 100%; height: 20px;"></div>		
10		8.6.3.1 9.9.1.3 9.2.3.8 9.1.3.8 9.1.3.4	15 15 15 12 8	65						
11		7.2.3.2 9.2.3.6 9.1.3.3 9.4.3.3	7 12 6 8	33						
12		8.8.1.4 9.1.1.2	18 8	connect 6						
13		7.4.5.1 9.4.2.3 9.1.2.3 9.9.9.4	15 10 8 13	46						
14		7.4.3.1 9.10.3.2 9.1.3.2	14 13 4	31						



Pilot: \_\_\_\_\_  
 AVC: \_\_\_\_\_



<b>B</b>	Contest:	Category:
	Date:	Program: Unknown1

Pilot:

wind direction

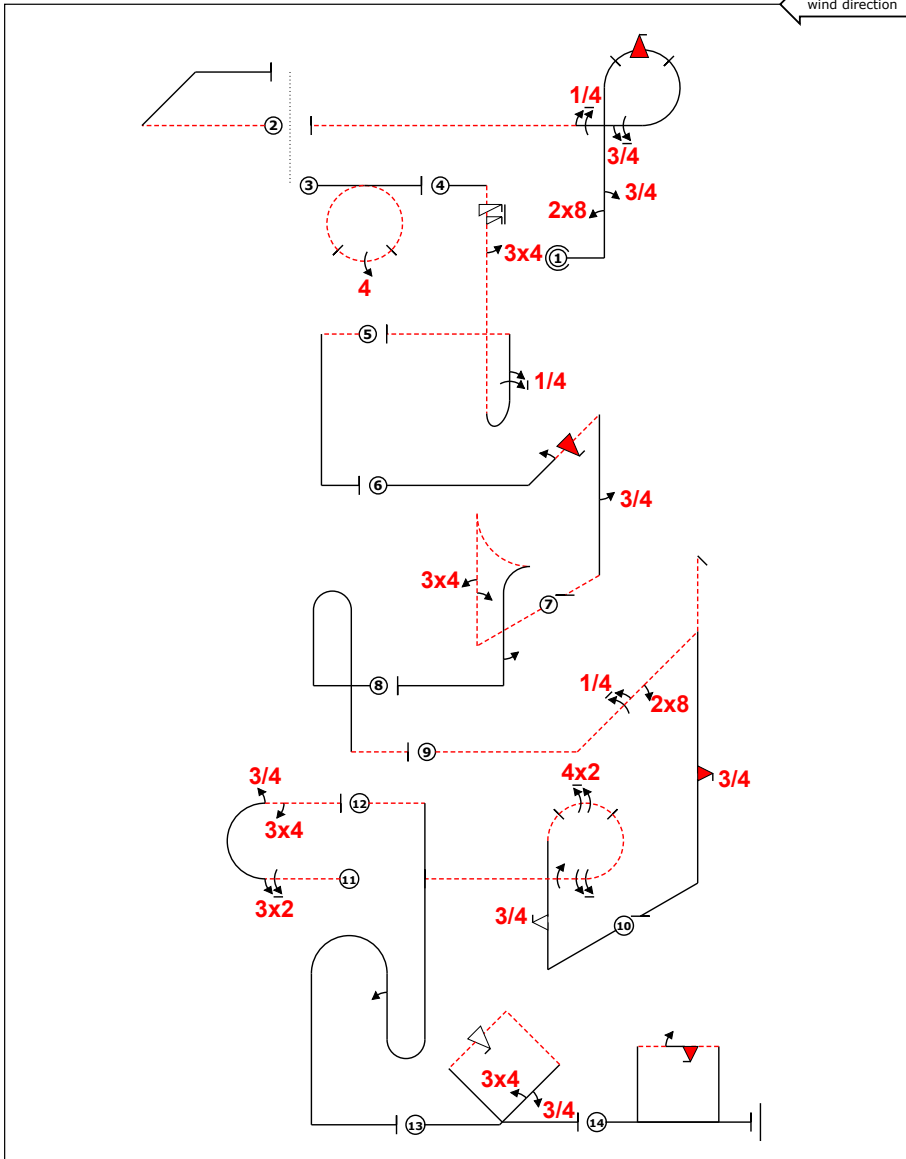

A/C:

(signature/date)

FREE PROGRAM CHECK BY:



<b>C</b>	Contest:	Category: <b>Unlimited</b>
	Date:	Program: <b>Unknown1</b>
		Pilot's No. <input type="text"/>

Pilot:

wind direction

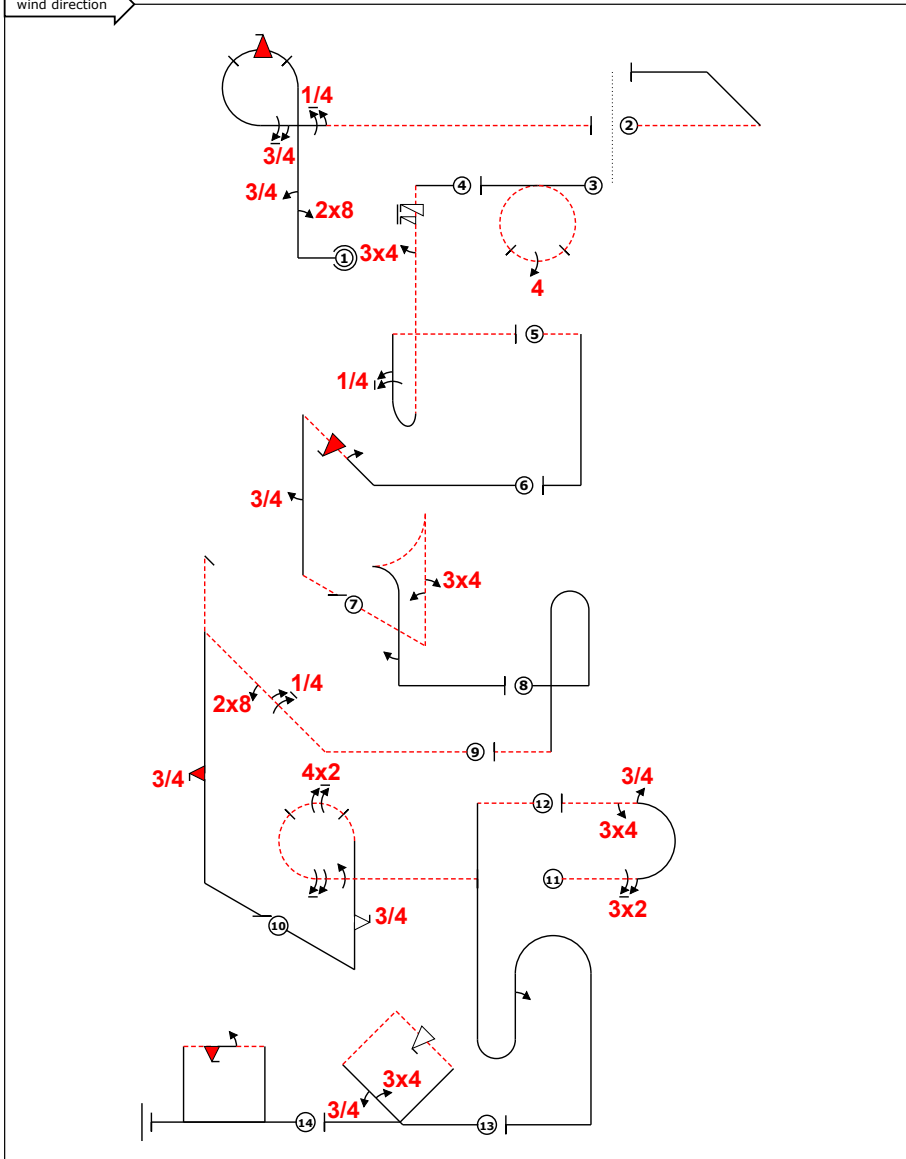

A/C:

(signature/date)

FREE PROGRAM CHECK BY: